

**Features**

Freq: 5~6GHz  
 360°Coverage, LSB = 11.25°  
 RMS Phase Error: 1°  
 Insertion Loss: 5 dB  
 Supply Voltage: -5V  
 Control Voltage: 0/+5V  
 Chip Size: 2.36mm×1.22mm×0.1mm

**General Description**

The HG154Y is a 5-bit GaAs pHEMT digital phase shifter which is rated from 5 to 6 GHz, providing 360 degrees of phase coverage, with a LSB of 11.25 degrees. The phase shifter features very low RMS phase error of 1.0 degrees and extremely low insertion loss of 5 dB across all phase states. This high accuracy phase shifter is controlled with positive logic of 0/+5V, and requires -5V bias supply.

**Electrical Specifications( $T_A=25\text{ }^\circ\text{C}$ ,  $V_{dd}=-5\text{V}$ )**

Parameter	Min.	Typ.	Max.
Frequency Range(GHz)	5~6		
Input VSWR	-	1.3	-
Output VSWR	-	1.2	-
Insertion Loss(dB)	-	5	-
Amplitude Variation(dB)	-	-0.4~1	-
Phase Error(°)	-	-4~2	-
RMS Phase Error(°)	-	1	-

**Truth Table(0: 0V, 1: +5V)**

State	PC1	PC2	PC3	PC4	PC5
0	0	0	0	0	0
-11.25°	1	0	0	0	0
-22.5°	0	1	0	0	0
-45°	0	0	1	0	0
-90°	0	0	0	1	0
-180°	0	0	0	0	1
-348.75°	1	1	1	1	1

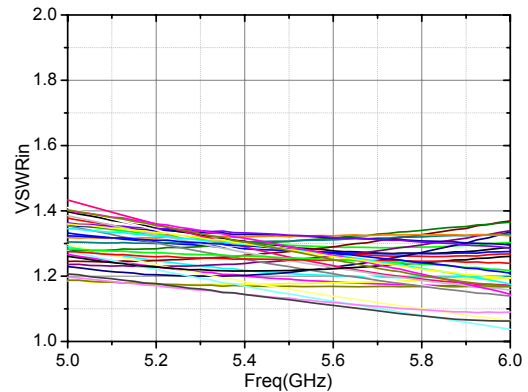
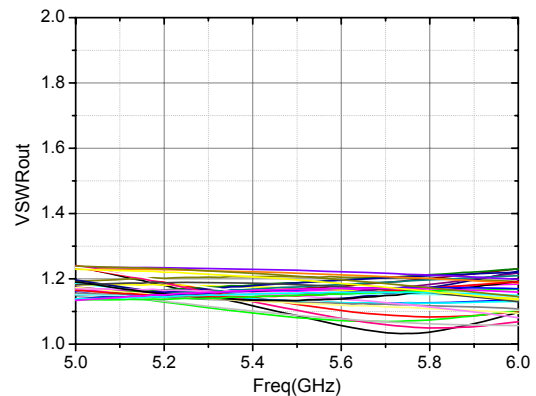
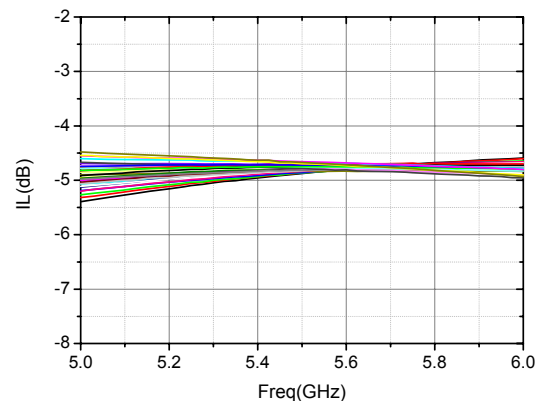
**Input VSWR**

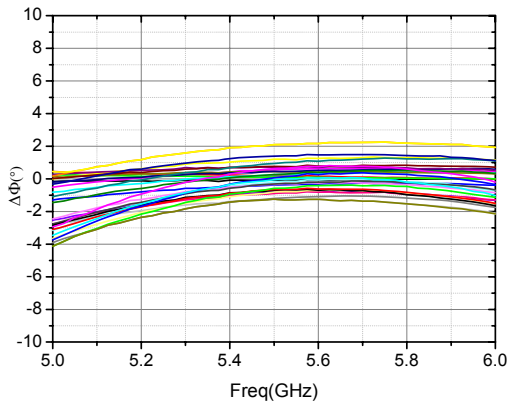
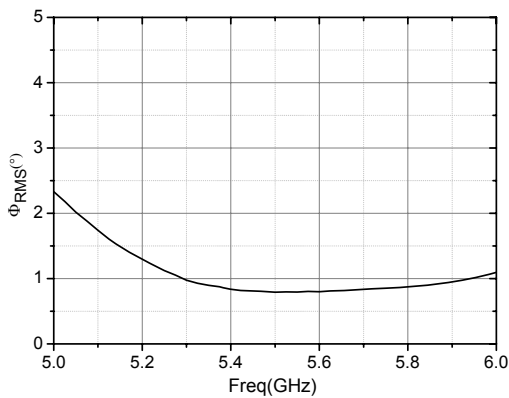
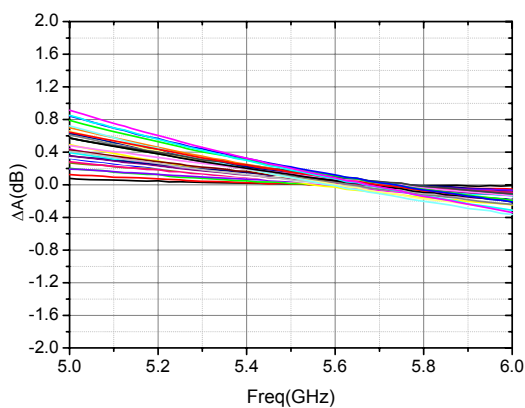
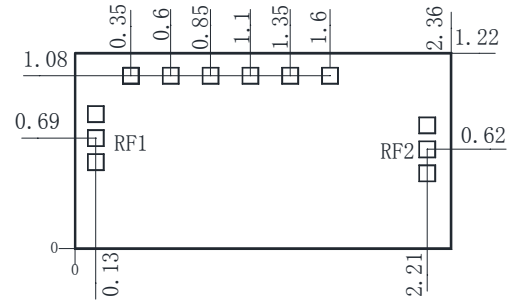
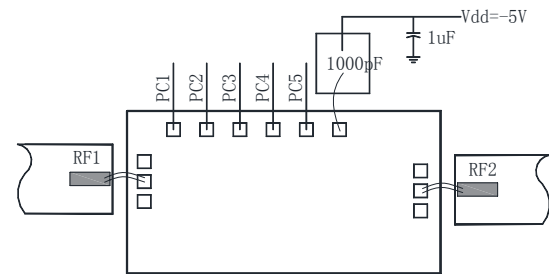
**Output VSWR**

**Insertion Loss**

**Phase Error**

**RMS Phase Error**

**Amplitude Variation**

**Outline Drawing (mm)**

**Assembly Diagram**

**Absolute Maximum Ratings**

Supply Voltage	-5.5V	
RF Input Power	+27dBm	
Control Voltage	Low Level: 0~0.5V	High Level: 3.7~5V
Operating Temperature	-55°C ~ 125°C	
Storage Temperature	-65°C ~ 150°C	

**Notes:**

1. The chip should be stored in a dry and nitrogen environment, and used in a clean environment.
2. GaAs material is brittle, can not touch the surface of the chip, must be careful when using.
3. The chip is welding with conductive adhesive or alloy (alloy temperature should not exceed 300°C, and no more than 30 sec. ), and should make it fully grounded.
4. The chip microwave port and substrate gap is not exceeding 0.05mm, with  $\Phi 25\mu\text{m}$  double gold wire bonding, suggested length of gold wire 250~400 $\mu\text{m}$ .
5. Chip microwave port without DC blocking capacitor.
6. The chip is sensitive to static electricity, and should be protected against static electricity during storage and use.